

---

# Bandagen

---

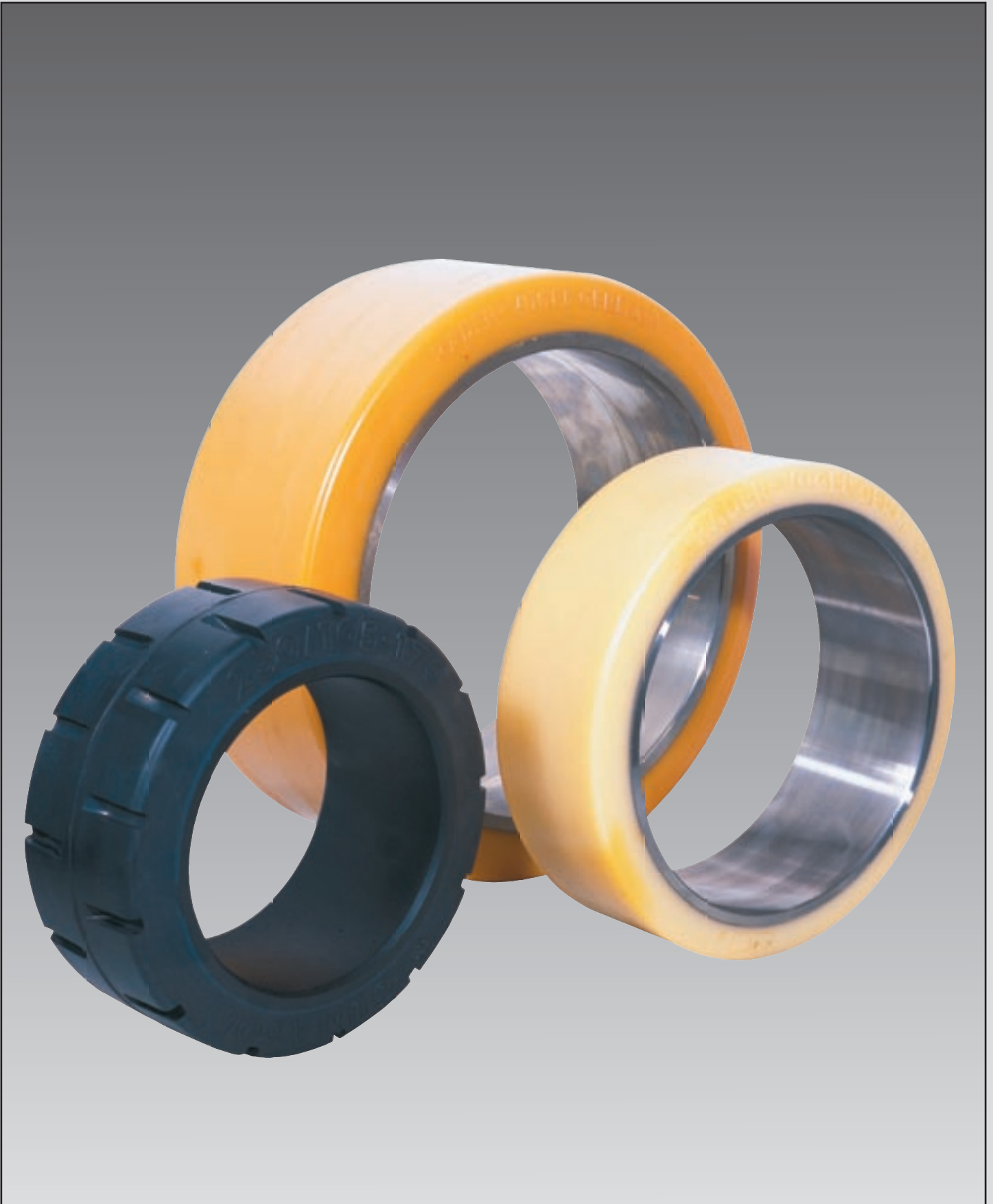

# Inhalt

## Bandagen

Wir fertigen eines der umfangreichsten Bandagen-Programme mit VULKOLLAN®-und PEVOPUR®- Laufbelägen. Alle gängigen metrischen und Zollabmessungen sind ab Lager oder in kürzester Zeit lieferbar. Zylindrische Stahlbandbandagen werden ab 100 mm bis zu einem Durchmesser von 920 mm und einer Tragfähigkeit von bis zu mehr als 10 t serienmäßig produziert. Zum besseren Aufpressen der Stahlbandbandagen wird jeder Innenring sauber ausgedreht und mit Untermaß für Felgen mit Passung h11 gefertigt.

280-18.500 kg



**Serie 179 Z**  
Seite 146

540-5.400 kg



**Serie 179 K**  
Seite 148

640-12.650 kg



**Serie 179 Z PUR**  
Seite 149

160-2.250 kg



**Serie 79 D**  
Seite 150

## Press-on-tyres

We produce one of the largest ranges of VULKOLLAN® and PEVOPUR® tyres. Most of the standard metric and inch dimensions are in stock or can be supplied within a short period of time. Cylindrical steel band tyres are produced as standard products with diameters ranging from 100 mm to 920 mm and load capacities up to more than 10 t. In order to ensure a better pressing on of the steel band tyres the inner ring is turned out and produced with slightly smaller dimensions than the specified ones for rims with fit h11.

160-1.575 kg



**Serie 79 K**  
Seite 150

250-3.750 kg



**Serie 79 S**  
Seite 151

## Bandages

Nous produisons une des gammes les plus étendues de bandages en VULKOLLAN® et PEVOPUR®. La plupart des dimensions standards en millimètres et pouces sont en stock ou peuvent être expédiées sous peu. Les bandages à base cylindrique en armature frette acier sont produits en série avec des diamètres de 100 mm à 920 mm et une capacité de charge jusqu' à plus de 10 t. Afin de faciliter le montage à force des bandages en armature frette acier la partie intérieure est tournée et produite avec des dimensions légèrement inférieures à celles spécifiées pour les jantes à ajustement h11.

PEVION®/PEVOTHAN®	30 - 53
Vollgummi	54 - 73
Elektrisch leitfähige Rollen	74 - 81
VULKOLLAN®/PEVOPUR®	82 - 99
Edelstahlrollen	100 - 109
Apparatrollen	110 - 117
Förderrollen/Kugelrollen	118 - 129
Profilrollen	130 - 135
Laufrollen/Bandagen	136 - 151



## Bandagen

### Serie 179 Z

### VULKOLLAN®-Bandagen

Zylindrische VULKOLLAN®-Bandagen mit mechanisch bearbeitetem Stahlring. Bandagen auch mit TRACTOTHAN®-Laufbelag lieferbar. Bestell-Code: 179 ZT...

### VULKOLLAN® press-on tyres

Cylindrical VULKOLLAN® press-on tyres with machined steel band. Also available with TRACTOTHAN® tread. Order code: 179 ZT...

### Bandages en VULKOLLAN®

Bandages cylindriques en VULKOLLAN® avec frette acier usiné. Aussi disponible avec bande de roulement en TRACTOTHAN®. Code de commande : 179 ZT...



Artikel-Code



D mm



W mm



d mm

D

ZOLL

W d  
Abmessung in Zoll



bei 6 km/h  
kg

179 Z/100/032/075	100	32	75				280
179 Z/100/070/055	100	70	55				600
179 Z/125/040/075	125	40	75				420
179 Z/125/050/075	125	50	75				540
179 Z/150/040/100	150	40	100				520
179 Z/150/050/100	150	50	100				640
179 Z/150/065/100	150	65	100				820
179 Z/150/075/100	150	75	100				960
179 Z/150/100/085	150	100	85				1.260
179 Z/150/130/100	150	130	100				1.640
179 Z/160/050/100	160	50	100				680
179 Z/160/075/100	160	75	100				1.020
179 Z/180/050/120	180	50	120				760
179 Z/180/075/120	180	75	120				1.140
179 Z/180/100/105	180	100	105				1.520
179 Z/200/050/140	200	50	140				840
179 Z/200/060/150	200	60	150				1.020
179 Z/200/070/140	200	70	140				1.180
179 Z/200/075/100	200	75	100				1.260
179 Z/200/080/120	200	80	120				1.360
179 Z/200/085/105	200	85	105				1.440
179 Z/200/105/120	200	105	120				1.780
179 Z/230/050/170	230	50	170				980
179 Z/230/075/170	230	75	170				1.460
179 Z/230/085/170	230	85	170				1.660
179 Z/250/050/190	250	50	190				1.060
179 Z/250/060/190	250	60	190				1.260
179 Z/250/075/140	250	75	140				1.580
179 Z/250/080/170	250	80	170				1.680
179 Z/250/100/170	250	100	170				2.100
179 Z/250/105/170	250	105	170				2.220
179 Z/250/105/190	250	105	190				2.220
179 Z/250/130/140	250	130	140				2.740
179 Z/254/076/203	254	76	203	10	x 3	x 8	1.640
179 Z/254/102/159	254	102	159	10	x 4	x 6 1/4	2.180
179 Z/254/102/165	254	102	165	10	x 4	x 6 1/2	2.180
179 Z/254/127/165	254	127	165	10	x 5	x 6 1/2	2.720
179 Z/260/085/170	260	85	170				1.860
179 Z/260/105/170	260	105	170				2.300
179 Z/267/089/203	267	89	203	10 1/2	x 3 1/2	x 8	2.000
179 Z/285/075/220	285	75	220				1.800
179 Z/285/100/200	285	100	200				2.400
179 Z/285/100/220	285	100	220				2.400
179 Z/285/100/228	285	100	228				2.400
179 Z/290/105/185	290	105	185				2.560
179 Z/300/050/240	300	50	240				1.260
179 Z/300/075/240	300	75	240				1.800

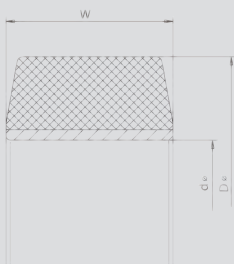

# Bandagen

## VULKOLLAN®-Bandagen

Zylindrische VULKOLLAN®-Bandagen mit mechanisch bearbeitetem Stahlring. Bandagen auch mit TRACTOTHAN®-Lauffbelag lieferbar. Bestell-Code: 179 ZT...



Artikel-Code



D  
mm



W  
mm



d  
mm

## Bandages en VULKOLLAN®

Bandages cylindriques en VULKOLLAN® avec frette acier usiné. Aussi disponible avec bande de roulement en TRACTOTHAN®. Code de commande : 179 ZT...

ZOLL

D W d  
Abmessungen in Zoll



bei 6 km/h  
kg

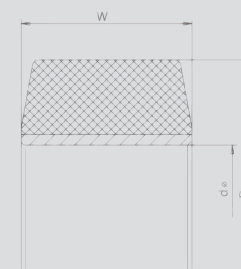

Artikel-Code	D mm	W mm	d mm	D ZOLL	W ZOLL	d ZOLL	bei 6 km/h kg
179 Z/300/090/203	300	90	203				2.160
179 Z/300/100/203	300	100	203				2.400
179 Z/310/060/220	310	60	220				1.480
179 Z/310/120/203	310	120	203				2.980
179 Z/310/120/220	310	120	220				2.980
179 Z/330/089/203	330	89	203	13	x 3 1/2	x 8	2.100
179 Z/330/089/254	330	89	254	13	x 3 1/2	x 10	2.350
179 Z/330/127/254	330	127	254	13	x 5	x 10	3.350
179 Z/330/145/193,5	330	145	193,5				3.820
179 Z/343/114/225	343	114	225				3.120
179 Z/343/140/203	343	140	203				3.840
179 Z/345/115/245	345	115	245				3.340
179 Z/350/090/280	350	90	280				2.600
179 Z/350/100/280	350	100	280				2.800
179 Z/350/110/270	350	110	270				3.080
179 Z/350/140/270	350	140	270				3.920
179 Z/360/085/270	360	85	270				2.450
179 Z/381/127/286	381	127	286	15	x 5	x 11 1/4	3.000
179 Z/381/152/286	381	152	286	15	x 6	x 11 1/4	3.500
179 Z/405/065/305	405	65	305				2.100
179 Z/405/130/290	405	130	290				3.800
179 Z/405/130/305	405	130	305				4.000
179 Z/405/145/290	405	145	290				4.100
179 Z/406/178/305	406	178	305				5.400
179 Z/415/075/305	415	75	305				2.500
179 Z/415/090/305	415	90	305				3.000
179 Z/445/178/381	445	178	381	17 1/2	x 7	x 15	6.000
179 Z/457/127/308	457	127	308	18	x 5	x 12 1/4	4.650
179 Z/457/152/308	457	152	308	18	x 6	x 12 1/4	4.950
179 Z/457/178/308	457	178	308	18	x 7	x 12 1/4	5.400
179 Z/457/203/308	457	203	308	18	x 8	x 12 1/4	5.800
179 Z/500/085/370	500	85	370				3.000
179 Z/559/152/406	559	152	406	22	x 6	x 16	5.950
179 Z/559/203/406	559	203	406	22	x 8	x 16	8.000
179 Z/559/229/406	559	229	406	22	x 9	x 16	8.950
179 Z/610/150/410	610	150	410				6.400
179 Z/645/250/500	645	250	500				11.300
179 Z/660/127/508	660	127	508	26	x 5	x 20	6.550
179 Z/711/178/559	711	178	559	28	x 7	x 22	8.850
179 Z/711/203/559	711	203	559	28	x 8	x 22	10.100
179 Z/711/254/559	711	254	559	28	x 10	x 22	12.650
179 Z/711/305/559	711	305	559	28	x 12	x 22	15.200
179 Z/750/150/640	750	150	640				7.880
179 Z/900/200/670	900	200	670				12.600
179 Z/914/254/762	914	254	762	36	x 10	x 30	16.250
179 Z/920/180/770	920	180	770				11.600
179 Z/920/290/770	920	290	770				18.500

## Serie 179 Z

PEVOION®/PEVOTHAN® 30 - 53  
 Vollgummi 54 - 73  
 Elektrisch leitfähige Rollen 74 - 81  
 VULKOLLAN®/PEVOPUR® 82 - 99  
 Edelstahlrollen 100 - 109  
 Apparaterollen 110 - 117  
 Förderrollen/Kugelrollen 118 - 129  
 Profilverollen 130 - 135  
 Laufrollen/Bandagen 136 - 151



## Bandagen

### Serie 179 K

#### VULKOLLAN®-Bandagen

VULKOLLAN®-Bandagen mit Stahlring. Mit konischem Reifenfuß mittengeteilt (km) oder seitengeteilt (ks). Bandagen auch mit TRACTOTHAN®-Laufbelag lieferbar. Bestell-Code: 179 KT/...

#### VULKOLLAN® press-on tyres

VULKOLLAN® press-on tyres with steel band. With conical base tyre, centre split (km) or laterally split (ks). Also available with TRACTOTHAN® tread. Order code: 179 KT...

#### Bandages en VULKOLLAN®

Bandages en VULKOLLAN® avec frette acier. Bandage à base conique, partagé centralement (km) ou latéralement (ks). Aussi disponible avec bande de roulement en TRACTOTHAN®. Code de commande : 179 KT...



Artikel-Code



mm



mm



mm



mm



kg

179 K/125/050/075	125	50	75	km 15	540
179 K/150/050/100	150	50	100	km 15	640
179 K/160/050/100	160	50	100	km 15	680
179 K/180/050/120	180	50	120	km 15	760
179 K/180/100/105	180	100	105	km 8	1.520
179 K/200/050/140	200	50	140	km 15	840
179 K/200/085/105	200	85	105	km 15	1.440
179 K/200/085/105 P	200	85	105	km 15	1.440
179 K/250/060/170	250	60	170	km 15	1.260
179 K/260/060/170	260	60	170	km 15	1.320
179 K/285/100/200	285	100	200	km 8	2.400
179 K/300/075/220	300	75	220	km 15	1.800
179 K/300/096/231	300	96	231	ks 23/9	2.300
179 K/310/075/200	310	75	200	km 15	1.860
179 K/310/120/200	310	120	200	ks 15/6	2.980
179 K/343/114/225	343	114	225	km 8	3.120
179 K/343/140/225	343	140	225	ks 15/6	3.840
179 K/406/127/267	406	127	267	ks 15/6	3.850
179 K/406/152/267	406	152	267	ks 15/6	4.600
179 K/406/178/267	406	178	267	ks 15/6	5.400
179 K/500/085/370	500	85	370	km 8	3.000

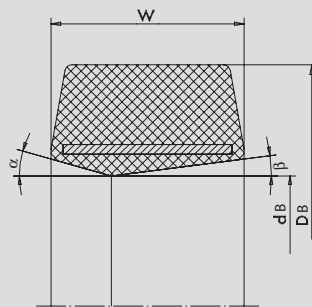

**ks = konischer Reifenfuß**  
seitengeteilt (asymmetrisch)  
ks 15/6 =  $\alpha 15^\circ, \beta 6^\circ$   
ks 23/9 =  $\alpha 23^\circ, \beta 9^\circ$

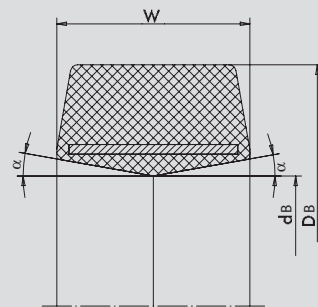

**km = konischer Reifenfuß**  
mittengeteilt (symmetrisch)  
km 15 =  $\alpha 15^\circ$   
km 8 =  $\alpha 8^\circ$

# PEVOPUR® Bandagen

## PEVOPUR®-Bandagen

Zylindrische PEVOPUR®-Bandagen mit mechanisch bearbeitetem Stahlring.

## PEVOPUR® press-on tyres

Cylindrical PEVOPUR® press-on tyres with machined steel band.

## Bandages en PEVOPUR®

Bandages cylindriques en PEVOPUR® avec frette acier usiné.

## Serie 179 Z PUR



Artikel-Code



D  
mm



W  
mm



d  
mm

ZOLL  
D W d  
Abmessungen im Zoll



bei 6 km/h  
kg

179 Z PUR/150/050/100	150	50	100				640
179 Z PUR/150/075/100	150	75	100				960
179 Z PUR/180/050/120	180	50	120				760
179 Z PUR/180/075/120	180	75	120				1.140
179 Z PUR/190/051/127	190	51	127				800
179 Z PUR/200/050/140	200	50	140				840
179 Z PUR/200/075/100	200	75	100				1.260
179 Z PUR/230/050/170	230	50	170				980
179 Z PUR/230/075/170	230	75	170				1.460
179 Z PUR/230/085/170	230	85	170				1.660
179 Z PUR/250/050/190	250	50	190				1.060
179 Z PUR/250/060/190	250	60	190				1.260
179 Z PUR/250/080/170	250	80	170				1.680
179 Z PUR/250/130/140	250	130	140				2.740
179 Z PUR/254/076/203	254	76	203	10	x 3	x 8	1.640
179 Z PUR/254/102/159	254	102	159	10	x 4	x 6 <sup>1</sup> / <sub>4</sub>	2.180
179 Z PUR/254/102/165	254	102	165	10	x 4	x 6 <sup>1</sup> / <sub>2</sub>	2.180
179 Z PUR/254/120/190	254	120	190				2.560
179 Z PUR/254/127/165	254	127	165	10	x 5	x 6 <sup>1</sup> / <sub>2</sub>	2.720
179 Z PUR/260/085/170	260	85	170				1.860
179 Z PUR/265/085/190,2 B	265	85	190				1.900
179 Z PUR/267/089/203	267	89	203	10 <sup>1</sup> / <sub>2</sub>	x 3 <sup>1</sup> / <sub>2</sub>	x 8	2.000
179 Z PUR/285/100/200	285	100	200				2.400
179 Z PUR/285/100/228	285	100	228				2.400
179 Z PUR/295/100/230	295	100	230				2.480
179 Z PUR/305/076/254	305	76	254	12	x 3	x 10	1.850
179 Z PUR/305/127/203	305	127	203	12	x 5	x 8	3.100
179 Z PUR/318/076/254	318	76	254	12 <sup>1</sup> / <sub>2</sub>	x 3	x 10	1.920
179 Z PUR/318/089/254	318	89	254	12 <sup>1</sup> / <sub>2</sub>	x 3 <sup>1</sup> / <sub>2</sub>	x 10	2.260
179 Z PUR/330/089/254	330	89	254	13	x 3 <sup>1</sup> / <sub>2</sub>	x 10	2.350
179 Z PUR/330/140/241,3	330	140	241	13	x 5 <sup>1</sup> / <sub>2</sub>	x 9 <sup>1</sup> / <sub>2</sub>	3.680
179 Z PUR/330/145/180	330	145	180				3.820
179 Z PUR/330/145/193,5	330	145	193				3.820
179 Z PUR/343/140/203	343	140	203				3.840
179 Z PUR/345/140/245	345	140	245				3.860
179 Z PUR/350/090/280	350	90	280				2.600
179 Z PUR/350/100/280	350	100	280				2.800
179 Z PUR/360/120/220	360	120	220				3.440
179 Z PUR/381/127/286	381	127	286	15	x 5	x 11 <sup>1</sup> / <sub>4</sub>	3.000
179 Z PUR/405/130/305	405	130	305				4.000
179 Z PUR/405/145/290	405	145	290				4.100
179 Z PUR/457/203/308	457	203	308	18	x 8	x 12 <sup>1</sup> / <sub>4</sub>	5.800
179 Z PUR/500/085/370	500	85	370				3.000
179 Z PUR/550/160/410	550	160	410				6.100
179 Z PUR/559/203/406	559	203	406	22	x 8	x 16	8.000
179 Z PUR/559/254/406	559	254	406	22	x 10	x 16	9.900
179 Z PUR/711/203/559	711	203	559	28	x 8	x 22	10.100
179 Z PUR/711/254/559	711	254	559	28	x 10	x 22	12.650

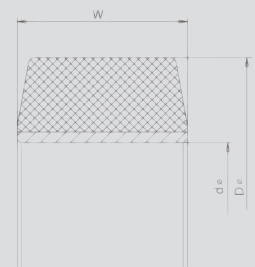

PEVOION®/PEVOTHAN®  
30 - 53

Vollgummi  
54 - 73

Elektrisch leitfähige Rollen  
74 - 81

VULKOLAN®/PEVOPUR®  
82 - 99

Edelstahlrollen  
100 - 109

Apparaterollen  
110 - 117













Förderrollen/Kugelrollen  
118 - 129

Profilrollen  
130 - 135

Laufrollen/Bandagen  
136 - 151



# Vollgummi-Bandagen

Serie 79 D	Vollgummi-Bandagen	Solid rubber press-on tyres	Bandages en caoutchouc plein		
	Zylindrisch mit Stahl Draht-armierung (D). Flachprofil, einige Größen auch mit Geländeprofil (P) und nicht kreidend auf Anfrage lieferbar	Cylindrical with steel wire core (D). Plain profile. Some sizes are available with cross-country profile (P) or non-marking.	Cylindriques, armés de tresses métalliques (D). Profile lisse. Quelques dimensions sont disponibles avec profil tous terrains (P) ou non tachant.		
	 Artikel-Code	 D mm	 W mm	 d mm	
	79 D/125/050/075 L	125	50	75	 bei 6 km/h kg
	79 D/150/050/100 L	150	50	100	160
	79 D/160/050/100 L	160	50	100	225
	79 D/180/050/120 A	180	50	120	250
	79 D/200/050/140 A	200	50	140	325
	79 D/200/075/100 L	200	75	100	350
	79 D/200/085/105 A	200	85	105	500
	79 D/230/050/170 L	230	50	170	550
	79 D/250/050/190 L	250	50	190	400
	79 D/250/060/170 L	250	60	170	450
	79 D/250/060/190 L	250	60	190	550
	79 D/250/080/170 L	250	80	170	525
	79 D/280/075/220 A	280	75	220	675
	79 D/300/075/220 L	300	75	220	725
	79 D/300/090/203 L	300	90	203	725
	79 D/310/060/220 L	310	60	220	900
	79 D/360/060/270 L	360	60	270	650
	79 D/360/075/270 A	360	75	270	750
	79 D/400/065/305 L	400	65	305	950
	79 D/400/075/305 L	400	75	305	900
	79 D/405/130/305 L	405	130	305	1000
	79 D/500/085/370 L	500	85	370	1500
79 D/610/150/410 A	610	150	410	1300	
				2250	
Serie 79 K	Vollgummi-Bandagen	Solid rubber press-on tyress	Bandages en caoutchouc plein		
	Vollgummi-Bandagen. Konisch mit Stahl Drahtarmierung.	Solid rubber press-on tyress. Conical (K) with steel wire core.	Bandages en caoutchouc plein. Bandages à base conique (K), armés de tresses métalliques.		
	 Artikel-Code	 D mm	 W mm	 d mm	
	79 K/125/050/075 L	125	50	75	 bei 6 km/h kg
	79 K/150/050/100 L	150	50	100	160
	79 K/160/050/100 L	160	50	100	225
	79 K/180/050/120 A	180	50	120	250
	79 K/180/075/100 L	180	75	100	325
	79 K/200/050/140 A	200	50	140	425
	79 K/200/075/100 A	200	75	100	350
	79 K/200/085/105 A	200	85	105	500
	79 K/250/075/140 A	250	75	140	550
	79 K/260/060/170 L	260	60	170	625
	79 K/300/100/203 A	300	100	203	525
	79 K/310/120/200 A	310	120	200	975
	79 K/343/140/203 A	343	140	203	ks 15/6
	79 K/360/060/270 L	360	60	270	ks 15/6
	79 K/406/127/267 A	406	127	267	13 1/2 x 5 1/2 x 8
	79 K/406/152/267 A	406	152	267	ks 15/6
					16 x 5 x 10 1/2
					16 x 6 x 10 1/2
					1050
					1350
					750
					1350
				1575	

A = Antriebsradqualität/drive wheel quality/qualité roue motrice L = Laufradqualität/running wheels quality/qualité roue porteuse

# Vollgummi-Bandagen

## Vollgummi-Bandagen

Vollgummi-Bandagen. Zylindrisch mit Stahlring (S) in Antriebsqualität. Flachprofil, einige Größen auch mit Geländeprofil (P) und nicht kreidend lieferbar.



Artikel-Code

79 S/160/050/100 A  
79 S/180/050/120 A  
79 S/200/050/140 A  
79 S/200/085/105 A  
79 S/230/050/170 A  
79 S/250/060/190 A  
79 S/250/080/170 A  
79 S/250/075/140 A  
79 S/250/105/170 A  
79 S/250/130/140 A  
79 S/254/102/165 A  
79 S/270/105/170 A  
79 S/285/075/220 A  
79 S/285/100/203 A  
79 S/300/075/240 A  
79 S/300/090/203 A  
79 S/405/065/305 A  
79 S/405/130/305 A  
79 S/415/075/305 A  
79 S/425/150/305 A  
79 S/457/203/308 A  
79 S/457/229/308 A  
79 S/550/160/410 A  
79 S/610/150/410 A  
79 S/620/200/410 A  
79 S/660/250/480 A



D  
mm



W  
mm



d  
mm

## Solid rubber press-on tyres

Solid rubber press-on tyres. Cylindrical with steel ring (S). For drive wheels. Plain profile. Some sizes also available with cross country profile (P) or non-marking.

## Bandages en caoutchouc plein

Bandages en caoutchouc plein. Cylindriques avec frette acier (S). Pour roues motrices. Profil lisse. Quelques dimensions sont disponibles avec profil tous terrains ou non tachant.

## Serie 79 S

ZOLL  
D W d  
Abmessungen in Zoll bei 6 km/h  
kg

D	W	d	bei 6 km/h
			250
			325
			350
			550
			400
			525
			675
			625
			845
			975
10	x 4	x 6 1/2	850
			900
			725
			960
			700
			900
			900
			1500
			1000
			1800
18	x 8	x 12 1/8	2250
18	x 9	x 12 1/8	2500
			2250
			2250
			3000
			3750

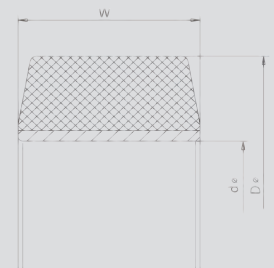

PEVOION®/PEVOTHAN®  
30 - 53

Vollgummi  
54 - 73

Elektrisch leitfähige Rollen  
74 - 81

VULKOLAN®/PEVOPUR®  
82 - 99

Edelstahlrollen  
100 - 109

Apparatrollen  
110 - 117

Förderrollen/Kugelrollen  
118 - 129

Profilrollen  
130 - 135

Laufrollen/Bandagen  
136 - 151